

JVC

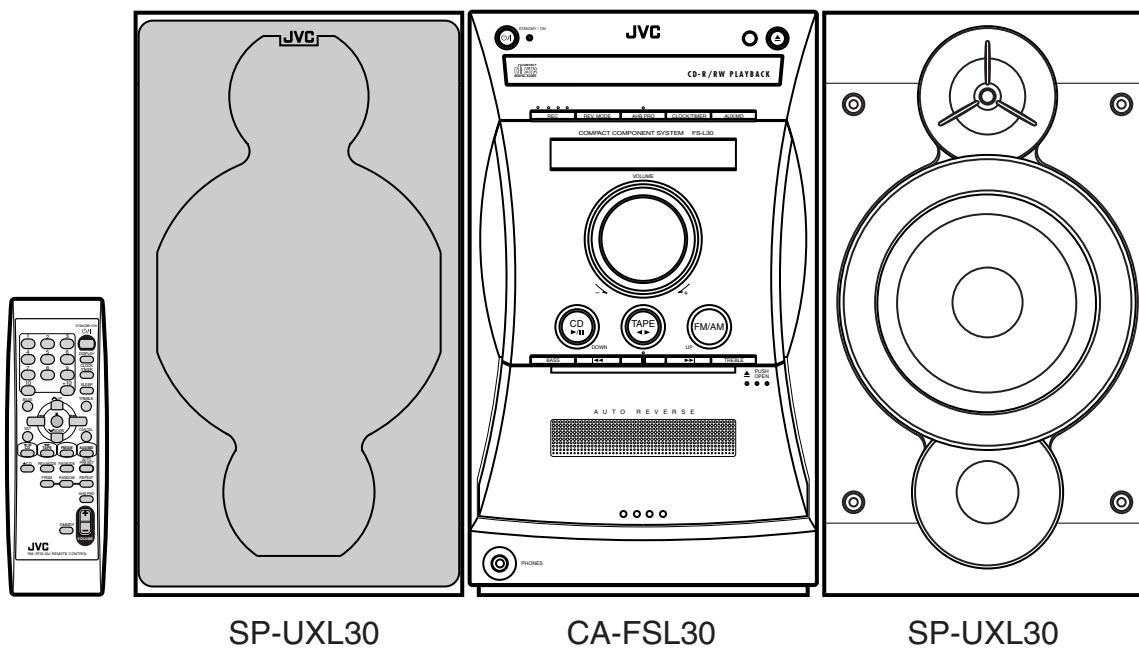

COMPACT COMPONENT SYSTEM

FS-L30—Consists of CA-FSL30 and SP-UXL30



COMPACT
disc
DIGITAL AUDIO

INSTRUCTIONS

For Customer Use:
Enter below the Model No. and Serial No.
which are located either on the rear, bot-
tom or side of the cabinet. Retain this
information for future reference.

Model No. _____
Serial No. _____

Warnings, Cautions and Others

Mises en garde, précautions et indications diverses

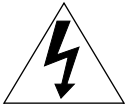
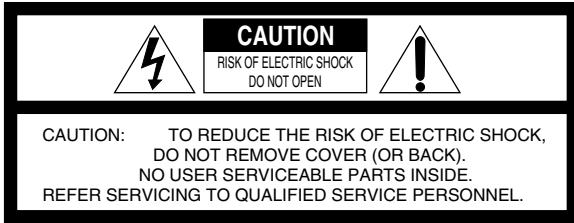

The lightning flash with arrowhead symbol, within an equilateral triangle is intended to alert the user to the presence of uninsulated "dangerous voltage" within the product's enclosure that may be of sufficient magnitude to constitute a risk of electric shock to persons.



The exclamation point within an equilateral triangle is intended to alert the user to the presence of important operating and maintenance (servicing) instructions in the literature accompanying the appliance.

For U.S.A.

This equipment has been tested and found to comply with the limits for a Class B digital device, pursuant to part 15 of the FCC Rules. These limits are designed to provide reasonable protection against harmful interference in a residential installation.

This equipment generates, uses and can radiate radio frequency energy and, if not installed and used in accordance with the instructions, may cause harmful interference to radio communications. However, there is no guarantee that interference will not occur in a particular installation. If this equipment does cause harmful interference to radio or television reception, which can be determined by turning the equipment off and on, the user is encouraged to try to correct the interference by one or more of the following measures:

Reorient or relocate the receiving antenna.

Increase the separation between the equipment and receiver.

Connect the equipment into an outlet on a circuit different from that to which the receiver is connected.

Consult the dealer or an experienced radio/TV technician for help.

WARNING: TO REDUCE THE RISK OF FIRE OR ELECTRIC SHOCK, DO NOT EXPOSE THIS APPLIANCE TO RAIN OR MOISTURE.

Caution — STANDBY/ON button!

Disconnect the mains plug to shut the power off completely (the STANDBY/ON lamp goes off).

The  STANDBY/ON button in any position does not disconnect the mains line.

- When the unit is on standby, the STANDBY/ON lamp lights red.
- When the unit is turned on, the STANDBY/ON lamp lights green.

The power can be remote controlled.

Attention — Commutateur STANDBY/ON!

Déconnectez la prise d'alimentation secteur pour mettre l'appareil complètement hors tension (le témoin STANDBY/ON s'éteint).

L'interrupteur  STANDBY/ON, sur n'importe quelle position, ne peut pas déconnecter l'appareil du secteur.

- Quand l'appareil est en mode de veille, le témoin STANDBY/ON est allumé en rouge.
- Quand l'appareil est sous tension, le témoin STANDBY/ON est allumé en vert.

L'alimentation peut être télécommandée.

CAUTION

To reduce the risk of electrical shocks, fire, etc.:

1. Do not remove screws, covers or cabinet.
2. Do not expose this appliance to rain or moisture.

ATTENTION

Afin d'éviter tout risque d'électrocution, d'incendie, etc.:

1. Ne pas enlever les vis ni les panneaux et ne pas ouvrir le coffret de l'appareil.
2. Ne pas exposer l'appareil à la pluie ni à l'humidité.

Note to CATV system installer:

This reminder is provided to call the CATV system installer's attention to Section 820-40 of the NEC which provides guidelines for proper grounding and, in particular, specifies that the cable ground shall be connected to the grounding system of the building, as close to the point of cable entry as practical.

-
1. CLASS 1 LASER PRODUCT
 2. **CAUTION:** Invisible laser radiation when open and interlock failed or defeated. Avoid direct exposure to beam.
 3. **CAUTION:** Do not open the top cover. There are no user serviceable parts inside the Unit; leave all servicing to qualified service personnel.

1. PRODUIT LASER CLASSE 1
2. **ATTENTION:** Radiation laser invisible quand l'appareil est ouvert ou que le verrouillage est en panne ou désactivé. Éviter une exposition directe au rayon.
3. **ATTENTION:** Ne pas ouvrir le couvercle du dessus. Il n'y a aucune pièce utilisable à l'intérieur. Laisser à un personnel qualifié le soin de réparer votre appareil.

For Canada/pour le Canada

CAUTION: TO PREVENT ELECTRIC SHOCK, MATCH WIDE BLADE OF PLUG TO WIDE SLOT, FULLY INSERT.

ATTENTION: POUR EVITER LES CHOCS ELECTRIQUES, INTRODUIRE LA LAME LA PLUS LARGE DE LA FICHE DANS LA BORNE CORRESPONDANTE DE LA PRISE ET POUSSER JUSQU'AU FOND.

For Canada/pour le Canada

THIS DIGITAL APPARATUS DOES NOT EXCEED THE CLASS B LIMITS FOR RADIO NOISE EMISSIONS FROM DIGITAL APPARATUS AS SET OUT IN THE INTERFERENCE-CAUSING EQUIPMENT STANDARD ENTITLED "DIGITAL APPARATUS," ICES-003 OF THE DEPARTMENT OF COMMUNICATIONS.

CET APPAREIL NUMERIQUE RESPECTE LES LIMITES DE BRUITS RADIOELECTRIQUES APPLICABLES AUX APPAREILS NUMERIQUES DE CLASSE B PRESCRITES DANS LA NORME SUR LE MATERIEL BROUILLEUR: "APPAREILS NUMERIQUES", NMB-003 EDICTEE PAR LE MINISTRE DES COMMUNICATIONS.

Introduction



We would like to thank you for purchasing one of our JVC products. Before operating this unit, read this manual carefully and thoroughly to obtain the best possible performance from your unit, and retain this manual for future reference.

About This Manual

This manual is organized as follows:

- The manual mainly explains operations using the buttons on the remote control. You can use the buttons both on the remote control and on the unit for the same operations if they have the same or similar names (or marks), unless mentioned otherwise.
- Basic and common information that is the same for many functions is grouped in one place, and is not repeated in each procedure. For instance, we do not repeat the information about turning on/off the unit, setting the volume, changing the sound effects, and others, which are explained in the section “Common Operations” on pages 9 and 10.
- The following marks are used in this manual:



Gives you warnings and cautions to prevent from damage or risk of fire/electric shock. Also gives you information which is not good for obtaining the best possible performance from the unit.



Gives you information and hints you had better know.

Precautions

Installation

- Install in a place which is level, dry and neither too hot nor too cold—between 5°C (41°F) and 35°C (95°F).
- Install the unit in a location with adequate ventilation to prevent internal heat built-up in the unit.
- Leave sufficient distance between the unit and the TV.
- Keep the speakers away from the TV to avoid interference with TV.



DO NOT install the unit in a location near heat sources, or in a place subject to direct sunlight, excessive dust or vibration.

Power sources

- When unplugging from the wall outlet, always pull the plug, not the AC power cord.



DO NOT handle the AC power cord with wet hands.

Moisture condensation

Moisture may condense on the lens inside the unit in the following cases:

- After starting heating in the room
 - In a damp room
 - If the unit is brought directly from a cold to a warm place
- Should this occur, the unit may malfunction. In this case, leave the unit turned on for a few hours until the moisture evaporates, unplug the AC power cord, and then plug it in again.

Others

- Should any metallic object or liquid fall into the unit, unplug the unit and consult your dealer before operating any further.
- If you are not going to operate the unit for an extended period of time, unplug the AC power cord from the wall outlet.



DO NOT disassemble the unit since there are no user serviceable parts inside.

If anything goes wrong, unplug the AC power cord and consult your dealer.

Contents

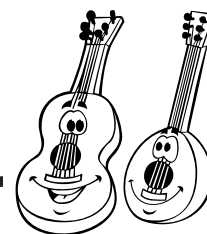

Location of the Buttons and Controls	3	Playing Back CDs (CD/CD-R/CD-RW)	13
Remote Control	3	Playing Back the Entire CD—Normal Play	13
Front Panel	4	Basic CD Operations	13
Getting Started	6	Programming the Playing Order of the Tracks	
Supplied Accessories	6	—Program Play	14
Putting the Batteries into the Remote Control	6	Playing at Random—Random Play	15
Connecting Antennas	6	Repeating Tracks—Repeat Play	15
Connecting Speakers	7	Prohibiting Disc Ejection—Tray Lock	15
Connecting Other Equipment	8	Playing Back Tapes	16
Common Operations	9	Playing Back a Tape	16
Setting the Clock	9	Recording	17
Turning On the Power	9	Recording on a Tape	17
Selecting the Sources and Starting Play	9	CD Direct Recording	18
Adjusting the Volume	10	One Track Recording	18
Adjusting the Tone (Bass/Treble)	10	Using the Timers	19
Reinforcing the Bass Sound	10	Using Daily Timer and Recording Timer	19
Selecting the Illumination Brightness	10	Using Sleep Timer	20
Listening to FM and AM Broadcasts	11	Maintenance	21
Tuning in to a Station	11	Troubleshooting	22
Presetting Stations	11	Specifications	22
Tuning in to a Preset Station	12		

Location of the Buttons and Controls

Become familiar with the buttons and controls on your unit.

Remote Control

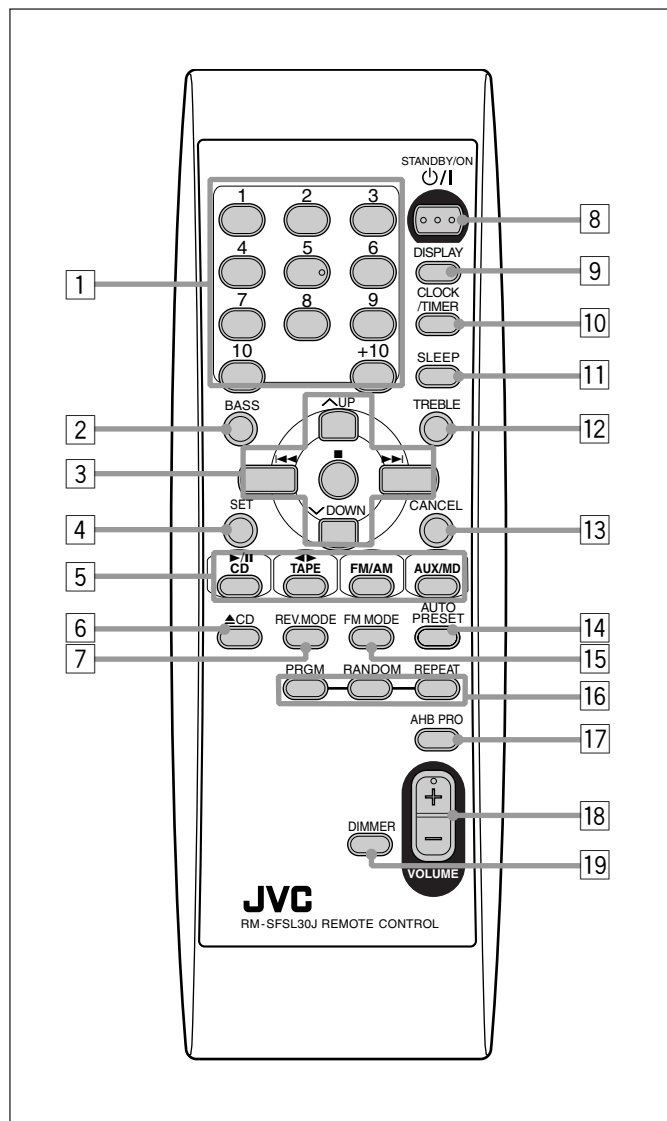

See pages in the parentheses for details.

Remote Control

- 1 Number buttons
- 2 BASS button (10)
- 3 Multi operation buttons
 - UP, ◀◀ (reverse skip), ■ (stop), ▶▶ (forward skip) and DOWN
- 4 SET button (12, 14)
- 5 Source buttons
 - CD ▶/⏏, TAPE ◀▶, FM/AM and AUX/MD

Pressing one of these buttons also turns on the unit.
- 6 ▲ CD (disc tray open/close) button (13)

Pressing this button also turns on the unit.
- 7 REV.MODE (reverse mode) button (16 – 18)
- 8 STANDBY/ON ⏏ button (9, 20)
- 9 DISPLAY button (9)
- 10 CLOCK/TIMER button (9, 19, 20)
- 11 SLEEP button (20)
- 12 TREBLE button (10)
- 13 CANCEL button (14)
- 14 AUTO PRESET button (11)
- 15 FM MODE button (11)
- 16 CD play mode buttons (14, 15)
 - PRGM (program), RANDOM and REPEAT
- 17 AHB (Active Hyper Bass) PRO button (10)
- 18 VOLUME + / – button (10)
- 19 DIMMER button (10)

Front Panel

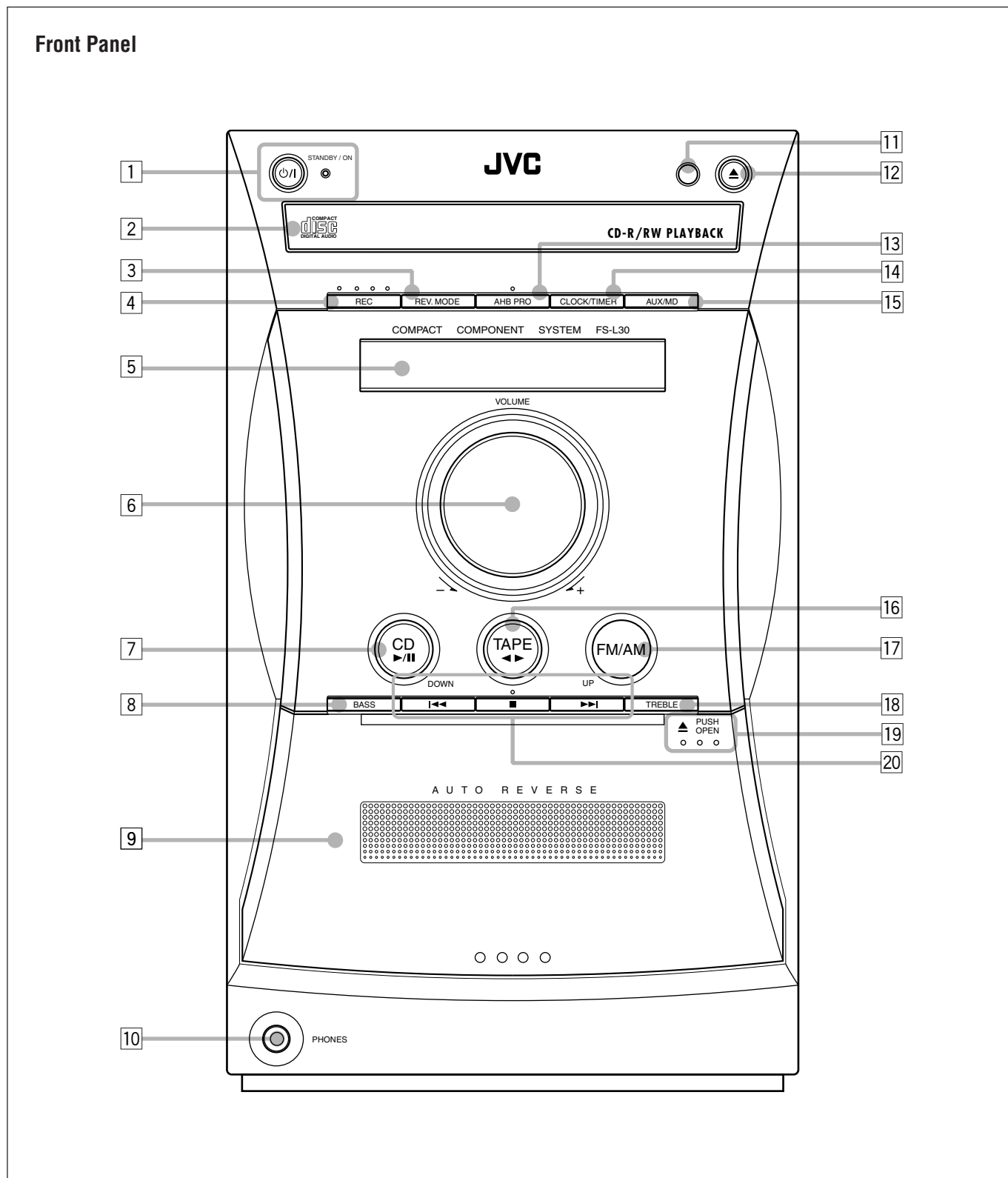

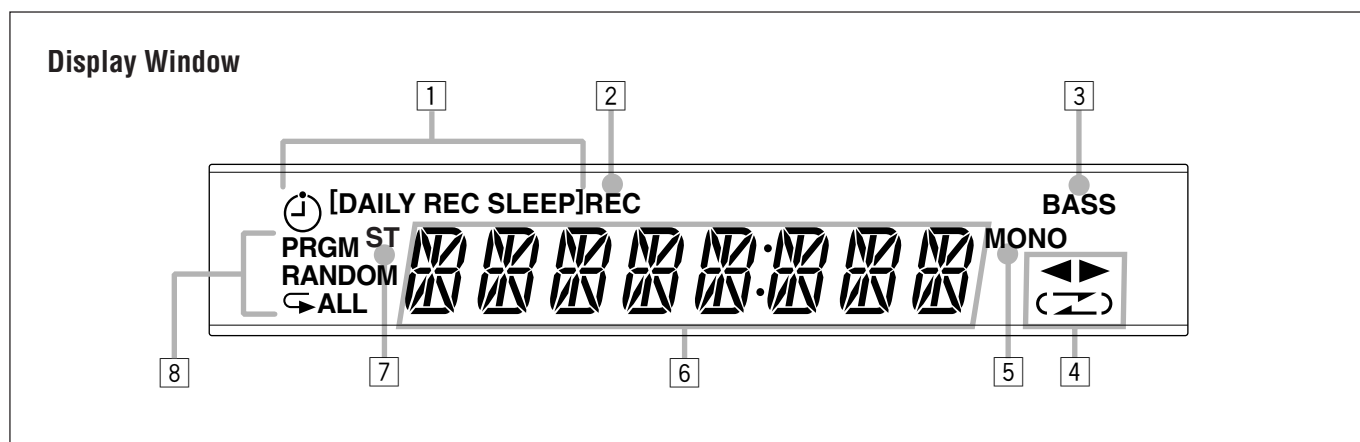

See pages in the parentheses for details.

Front Panel

- 1 STANDBY/ON button and STANDBY/ON lamp (9, 15, 20)
- 2 Disc tray
- 3 REV.MODE (reverse mode) button (16 – 18)
- 4 REC (recording) button (17, 18)
- 5 Display window
- 6 VOLUME + / – control (10)
- 7 CD (play/pause) button (9, 13, 15, 18)
Pressing this button also turns on the unit.
- 8 BASS button (10)
- 9 Cassette holder
- 10 PHONES jack (10)
- 11 Remote sensor
- 12 (disc tray open/close) button (13)
Pressing this button also turns on the unit.
- 13 AHB (Active Hyper Bass) PRO button (10)
- 14 CLOCK/TIMER button (9, 19, 20)
- 15 AUX/MD button (9)
Pressing this button also turns on the unit.
- 16 TAPE button (9, 16, 17)
Pressing this button also turns on the unit.
- 17 FM/AM button (9, 11, 12)
Pressing this button also turns on the unit.
- 18 TREBLE button (10)
- 19 PUSH OPEN (cassette holder open) portion (16 – 18)
- 20 Multi operation buttons
 - (reverse skip)/DOWN, (stop)
 - and (forward skip)/UP

Display Window

- 1 Timer indicators
 - (timer), DAILY, REC and SLEEP
- 2 REC (recording) indicator
- 3 BASS indicator
- 4 Tape operation indicators
 - (tape direction) and (reverse mode)
- 5 MONO indicator
- 6 Main display
 - Shows the source name, frequency, etc.
- 7 ST (stereo) indicator
- 8 CD play mode indicators
 - PRGM (program), RANDOM and ALL (repeat one/repeat all)

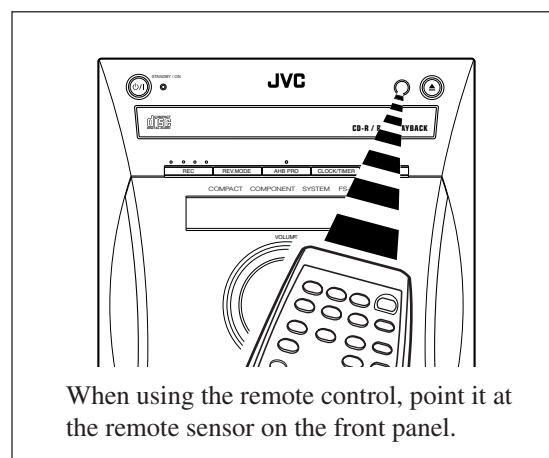

Supplied Accessories

Make sure that you have all the following items.
The number in the parentheses indicates the quantity of the pieces supplied.

- AM loop antenna (1)
- FM antenna (1)
- Remote control (1)
- Batteries (2)

If anything is missing, consult your dealer immediately.

Putting the Batteries into the Remote Control

Insert the batteries—R6(SUM-3)/AA(15F)—into the remote control, by matching the polarity (+ and –) on the batteries with the + and – markings on the battery compartment.

When the remote control can no longer operate the unit, replace both batteries at the same time.

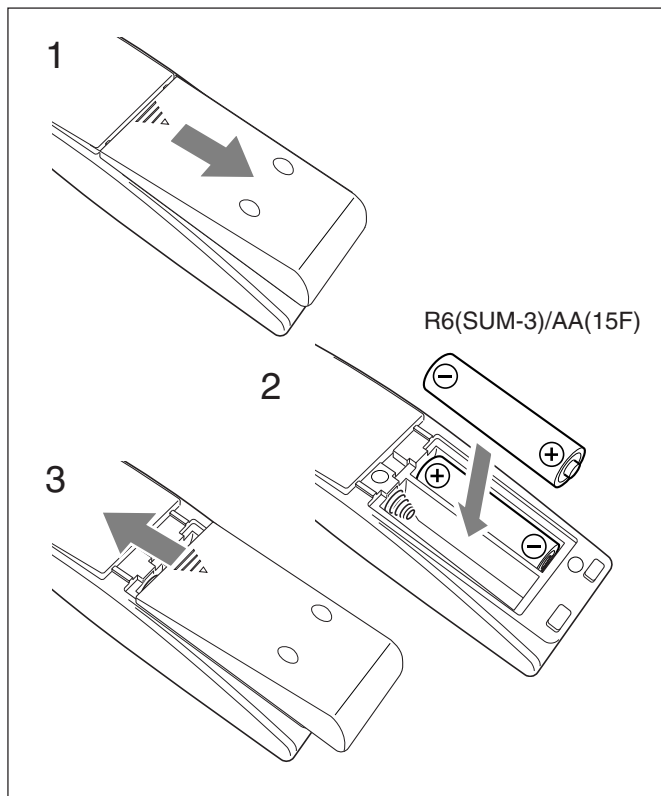

- DO NOT use an old battery together with a new one.
- DO NOT use different types of batteries together.
- DO NOT expose batteries to heat or flame.
- DO NOT leave the batteries in the battery compartment when you are not going to use the remote control for an extended period of time. Otherwise, it will be damaged from battery leakage.

Connecting Antennas

FM antenna

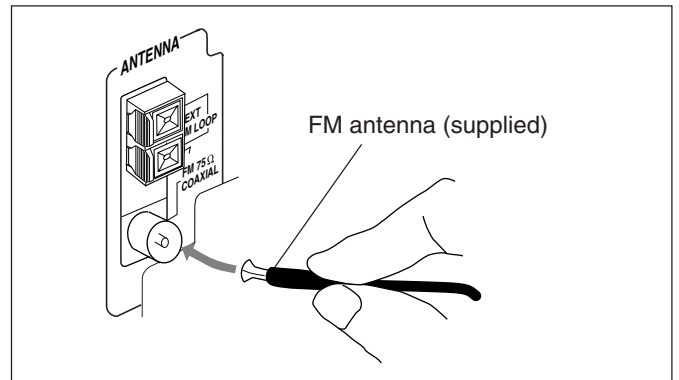

- 1 Attach the FM antenna to the FM 75 Ω COAXIAL terminal.
- 2 Extend the FM antenna.
- 3 Fasten it up in the position which gives you the best reception, then fix it on the wall, etc.



About the supplied FM antenna

The FM antenna supplied with this unit can be used as temporary measure. If reception is poor, you can connect an outdoor FM antenna.

To connect an outdoor FM antenna

Before connecting it, disconnect the supplied FM antenna.

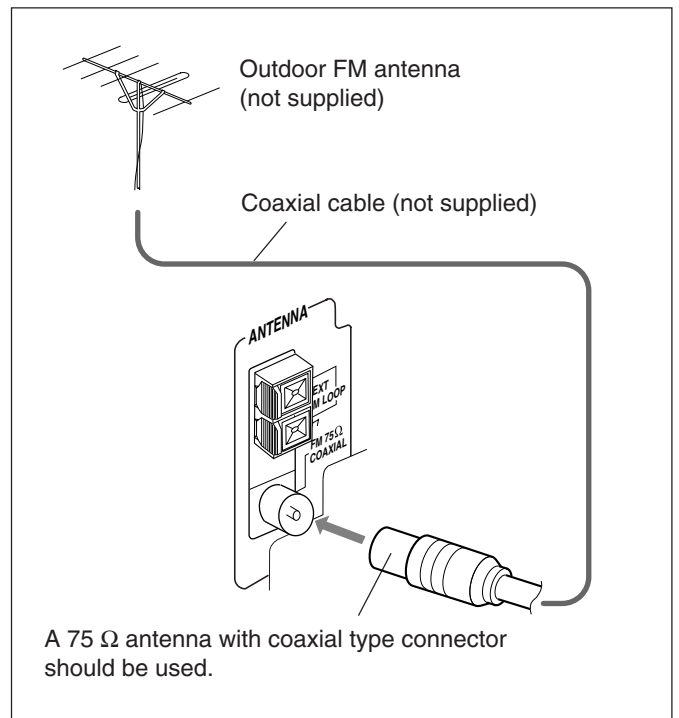

AM antenna

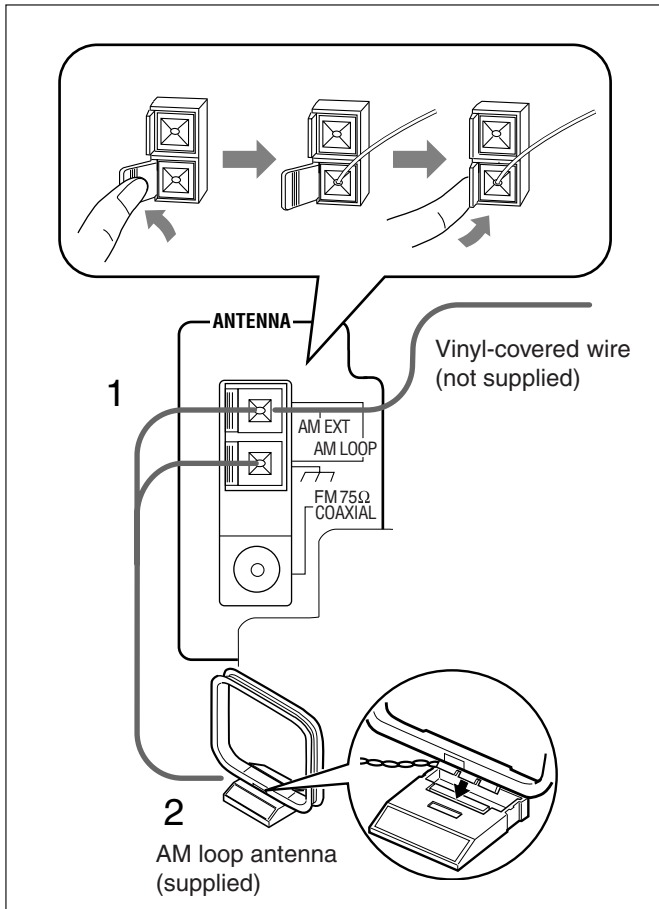

1 Connect the AM loop antenna to the AM LOOP terminals as illustrated.

- If cords are covered with insulation, twist the core of the cord at the end of each cord, then remove the insulation.

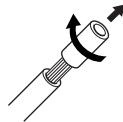

2 Turn the AM loop antenna until you have the best reception.

To connect an outdoor AM antenna

When reception is poor, connect a single vinyl-covered wire to the AM EXT terminal and extend it horizontally. (The AM loop antenna must remain connected.)



For better reception of both FM and AM

- Make sure the antenna conductors do not touch any other terminals and connecting cords.
- Keep the antennas away from metallic parts of the unit, connecting cords, and the AC power cord.

Connecting Speakers

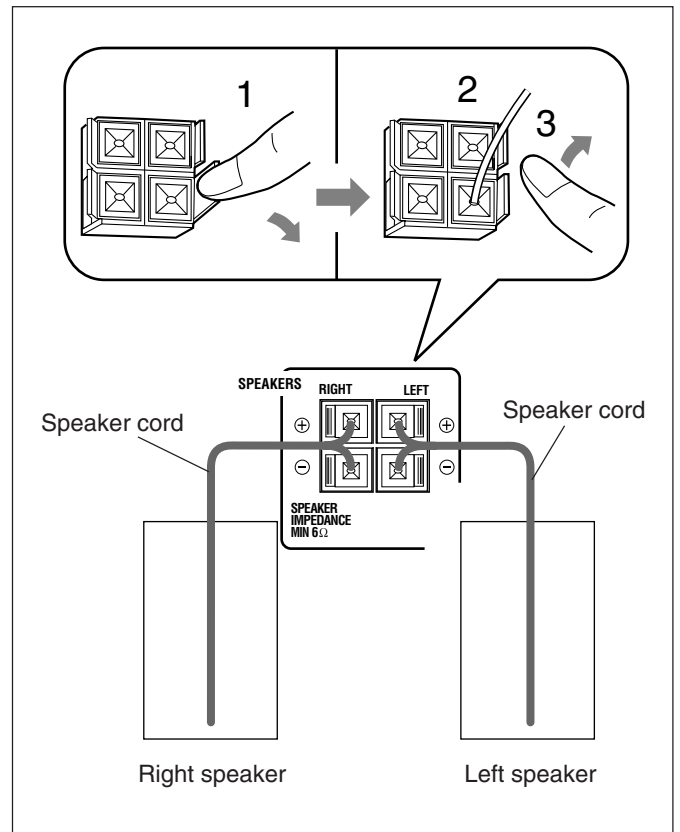

1 Press and hold the clamp of the speaker terminal on the rear of the unit.

2 Insert the end of the speaker cord to the terminal.

Match the polarity between the unit and the speaker terminals: (+) to (+) and (-) to (-).

- If cords are covered with insulation, twist the core of the cord at the end of each cord, then remove the insulation.

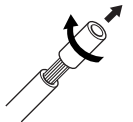

3 Release the finger from the clamp.

IMPORTANT: Use only speakers with the same speaker impedance as indicated by the speaker terminals on the rear of the unit.



To remove the speaker grilles

The speaker grilles are removable.

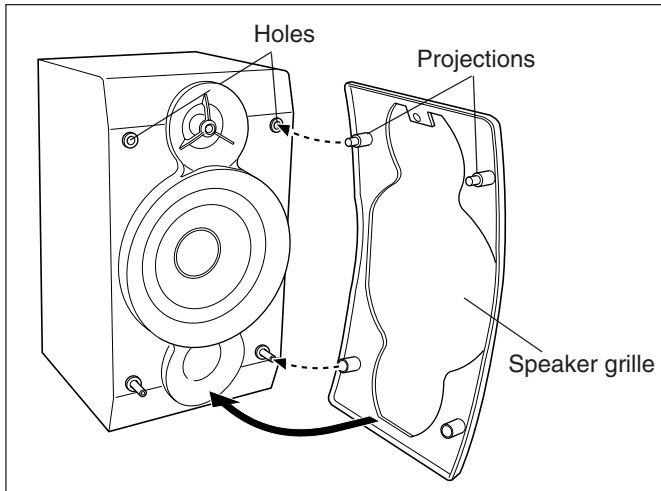

To remove the speaker grille, insert your fingers at the top of the speaker grille, pull towards you. Then pull the bottom towards you.

To attach the speaker grille, put the projections of the speaker grille into the holes of the speaker.

Connecting Other Equipment

You can connect both of the analog and digital equipment.



- DO NOT connect any equipment while the power is on.
- DO NOT plug in any equipment until all connections are complete.

To connect audio equipment

Be sure that the plugs of the audio cords are colored: White plugs and jacks are for left audio signals, and red ones for right audio signals.

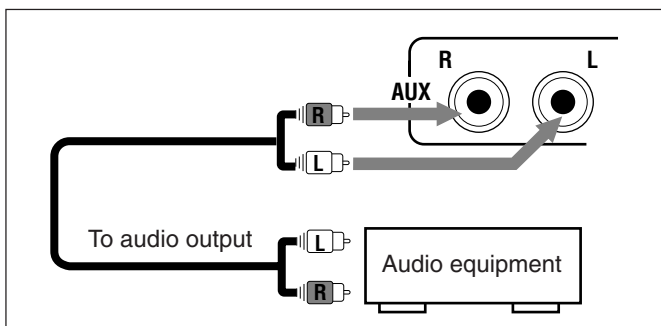

For playing the other equipment through this unit, connect between the audio output jacks on the other equipment and AUX jacks by using audio cords (not supplied).

To connect audio equipment with an optical digital input terminal

You can record CD sound onto the connected digital equipment.

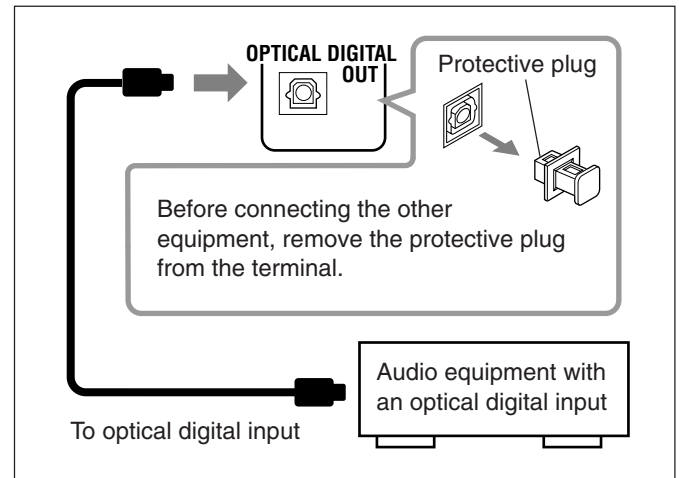

Connect an optical digital cord (not supplied) between the optical digital input terminal on the other equipment and the OPTICAL DIGITAL OUT terminal.

Now, you can plug the AC power cord.

IMPORTANT: Be sure to check all connections to be done before plugging the AC power cord into a wall outlet.

Common Operations

Setting the Clock

Before operating the unit any further, first set the clock built in this unit. When you plug the AC power cord into the wall outlet, “AM12:00” starts flashing on the display.

You can set the clock whether the unit is on or off.

- There is a time limit in doing the following steps. If the setting is canceled before you finish, start from step 1 again.

1 Press CLOCK/TIMER.

The hour digits start flashing on the display.

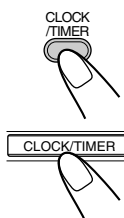

2 Press UP or DOWN to adjust the hour, then press CLOCK/TIMER.

The minute digits start flashing on the display.

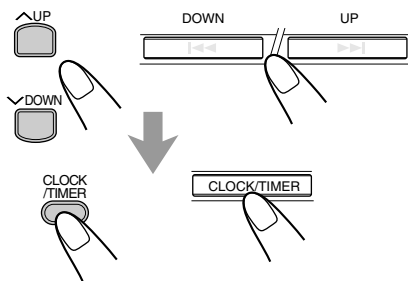

3 Press UP or DOWN to adjust the minute, then press CLOCK/TIMER.

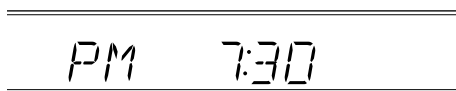

To check the clock time during play

On the remote control ONLY:

Press DISPLAY.

- Each time you press the button, the source indication and the clock time alternate on the display.



- **When you unplug the AC power cord or if a power failure occurs**
The clock is reset to “AM12:00” right away. If this happens, set the clock again.
- **The clock may gain or lose 1 to 2 minutes per month**
If this happens, set the clock again.

To adjust the clock again

- 1 **Make sure** ☉ (timer) indicator is not lit on the display.
 - If it is lit, press and hold CLOCK/TIMER until it goes off.
- 2 **Press CLOCK/TIMER repeatedly until the unit enters the clock setting mode (the hour digit start flashing on the display).**
First time you press CLOCK/TIMER, the unit enters the timer setting mode.
 - See pages 19 and 20.
- 3 **Repeat steps 2 and 3 of the procedure of “Setting the Clock.”**
- 4 **Press and hold CLOCK/TIMER again so that** ☉ (timer) indicator goes off from the display.

Turning On the Power

When you press the play button—CD ►/II, TAPE ◀▶, FM/AM and AUX/MD, the unit automatically turns on and starts playback if the source is ready.

To turn on the unit, press STANDBY/ON ⏻/I.

The STANDBY/ON lamp lights green and “HELLO” appears on the display.

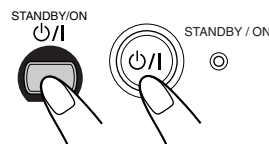

To turn off the unit (on standby), press STANDBY/ON ⏻/I again.

The STANDBY/ON lamp lights red and “GOOD BYE” appears on the display.

- “AM12:00” flashes on the display until you set the built-in clock. After setting the clock, the clock time will appear on the display while the unit is on standby.
- A little power is always consumed even while the unit is on standby.

To switch off the power supply completely, unplug the AC power cord from the AC outlet.



When you unplug the AC power cord or if a power failure occurs

The clock is reset to “AM12:00” right away, while the tuner preset stations (see page 11) will be erased in a few days.

Selecting the Sources and Starting Play

To play back CDs, press CD ►/II. (See pages 13 – 15.)

To play back tapes, press TAPE ◀▶. (See page 16.)

To listen to FM/AM broadcasts, press FM/AM. (See pages 9 – 10.)

To select the external equipment as the source, press AUX/MD.

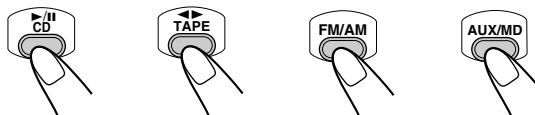

When you press the play button for a particular source (CD ►/II, TAPE ◀▶, FM/AM and AUX/MD), the unit turns on (and the unit starts playing the source if it is ready).

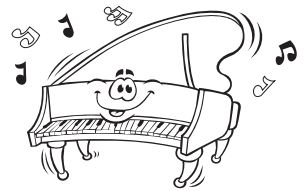

Adjusting the Volume

You can adjust the volume level only while the unit is turned on. The volume level can be adjusted between “VOL MIN” and “VOLUME 1” – “VOLUME 40 (VOL MAX).”

When using the remote control, press VOLUME + to increase the volume or press VOLUME – to decrease it.

When using the unit, turn VOLUME + / – clockwise (+) to increase the volume or counterclockwise (–) to decrease it.

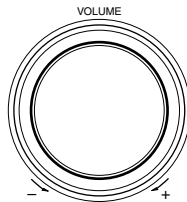

For private listening

Connect the headphones to the PHONES jack. No sound comes out of the speakers. Be sure to turn down the volume before connecting or putting on headphones.



DO NOT turn off (on standby) the unit with the volume set to an extremely high level; otherwise, a sudden blast of sound can damage your hearing, speakers and/or headphones when you turn on the unit or start playing any source next time. **REMEMBER** you cannot adjust the volume level while the unit is on standby.

Adjusting the Tone (Bass/Treble)

You can adjust the bass level (low frequency range) and the treble level (high frequency range) within the range of –5 to +5. Normally set these to 0 (initial setting at factory).

- This function only affects the playback sound, but does not affect your recording.
- There is a time limit in doing the following steps. If the setting is canceled before you finish, start from step 1 again.

1 Press BASS to adjust the bass level or press TREBLE to adjust the treble level.

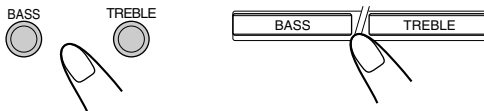

2 Press UP to increase the level or press DOWN to decrease it.

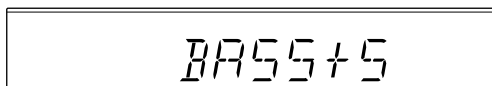
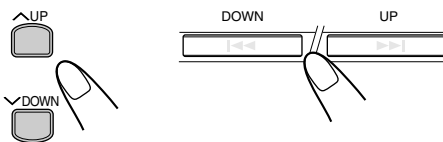

Reinforcing the Bass Sound

You can reinforce the bass sound to maintain rich, full bass at low volume.

- This function only affects the playback sound, but does not affect your recording.

To get the effect, press AHB (Active Hyper Bass) PRO until “AHB 1” or “AHB 2” appears on the display. The BASS indicator also lights up on the display.



- Each time you press the button, the bass sound change as follows:

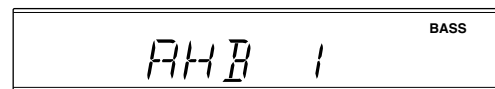
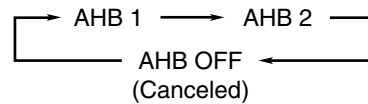

“AHB 2” has much more bass reinforcement effect than “AHB 1.”

To cancel the effect, press AHB PRO until “AHB OFF” appears on the display and the BASS indicator goes off.

Selecting the Illumination Brightness

You can change the illumination brightness only while the unit is turned on.

On the remote control ONLY:

To change the brightness, press DIMMER.

- Each time you press the button, the illumination dims and brightens alternately.



Listening to FM and AM Broadcasts

Tuning in to a Station

1 Press FM/AM to select the band.

The unit automatically turns on and tunes in to the previously received station (either FM or AM).

- Each time you press the button, the band alternates between FM and AM.



2 Press and hold >>> or <<< for more than 1 second.

The unit starts searching for stations and stops when a station of sufficient signal strength is tuned in.

If a program is broadcast in stereo, the ST (stereo) indicator lights up.

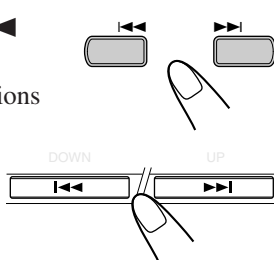

To stop searching, press >>> or <<<.



When you press >>> or <<< briefly and repeatedly the frequency changes step by step.

To change the FM reception mode

On the remote control ONLY:

When an FM stereo broadcast is hard to receive or noisy, press FM MODE so that the MONO indicator lights up on the display. Reception improves.

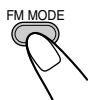
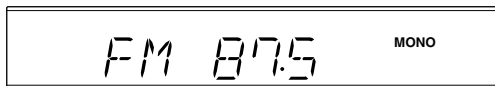

To restore the stereo effect, press FM MODE again so that the MONO indicator goes off. In this stereo mode, you can hear stereo sounds when a program is broadcasted.

Presetting Stations

You can preset 30 FM and 15 AM stations—using either automatic presetting or manual presetting.

In some cases, test frequencies have been already memorized for the tuner since the factory examined the tuner preset function before shipment. This is not a malfunction. You can preset the stations you want into memory by following the presetting method.

To preset stations automatically—Automatic Presetting

You need to preset stations separately for the FM and AM bands.

On the remote control ONLY:

1 Press FM/AM to select the band you want to preset.

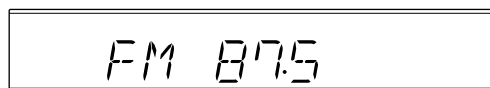

2 Press and hold AUTO PRESET for more than 2 seconds.

Local stations with strong signals are searched and stored in memory automatically.

When automatic presetting is over, the station stored in preset number 1 is received.



3 Repeat steps 1 and 2 to store stations for the other band.



- **When you cannot automatically store stations you want**
Stations with weak signals cannot be detected with this automatic presetting. To store such a station, use the manual presetting.
- **When you unplug the AC power cord or if a power failure occurs**
Preset stations with the automatic presetting are erased at once. If this happens, preset the stations again.



To preset stations manually—Manual Presetting

You need to preset stations separately for the FM and AM bands.

- There is a time limit in doing the following steps. If the setting is canceled before you finish, start from step 2 again.

On the remote control ONLY:

1 Tune in to the station you want to preset.

- See “Tuning in to a Station” on page 11.

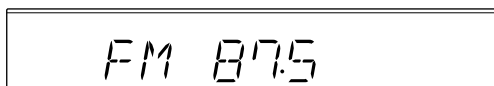

2 Press SET.



3 Press UP or DOWN to select a preset number.

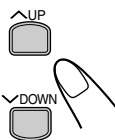
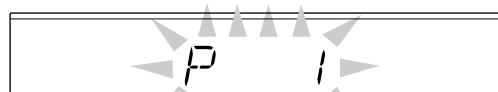

4 Press SET again.



The tuned station in step 1 is stored in the preset number selected in step 3.

- Storing a new station on a used number erases the previously stored one.



When you unplug the AC power cord or if a power failure occurs

The tuner preset stations will be erased in a few days. If this happens, preset the stations again.

Tuning in to a Preset Station

On the remote control ONLY:

1 Press FM/AM to select the band.

The unit automatically turns on and tunes in to the previously received station (either FM or AM).



- Each time you press the button, the band alternates between FM and AM.

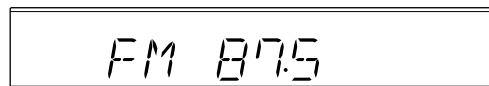

2 Press UP or DOWN to select a preset number.

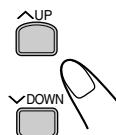

To tune a preset number directly using the number buttons

On the remote control ONLY:

Pressing the number button(s) allows you to select a preset number you want.

- Ex.:
- For preset number 5, press 5.
 - For preset number 15, press +10, then 5.
 - For preset number 20, press +10, then 10.
 - For preset number 30, press +10, +10, then 10.

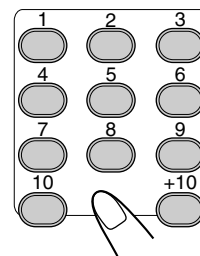

Playing Back CDs (CD/CD-R/CD-RW)

This unit has been designed to playback the following CDs:

- CD
- CD-R
- CD-RW

Continued use of irregular shape CDs (heart-shape, octagonal, etc.) can damage the unit.

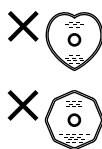

General Notes

In general, you will have the best performance by keeping your CDs and the mechanism clean.

- Store CDs in their cases, and keep them in cabinets or on shelves.
- Keep the unit's disc tray closed when not in use.

When playing a CD-R or CD-RW

User-edited CD-Rs (CD-Recordable) and CD-RWs (CD-ReWritable) can be played back only if they are already "finalized."

- You can play back your original CD-Rs or CD-RWs recorded in music CD format. However, they may not be played back depending on their characteristics or recording conditions.
- Before playing back CD-Rs or CD-RWs, read their instructions or cautions carefully.
- Some CD-Rs or CD-RWs may not be played back on this unit because of their disc characteristics, damage or stain on them, or if the player's lens is dirty.
- CD-RWs may require a longer readout time. This is caused by the fact that the reflectance of CD-RWs is lower than for regular CDs.

Playing Back the Entire CD—Normal Play

1 Press CD on the remote control (or on the unit).

The unit automatically turns on and the disc tray comes out.



2 Place a disc correctly on the circle of the disc tray, with its label side up.

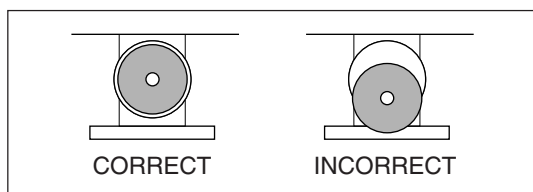

- When using a CD single (8 cm), place it on the inner circle of the disc tray.

3 Press CD .

The disc tray automatically closes and the first track of the CD starts playing.

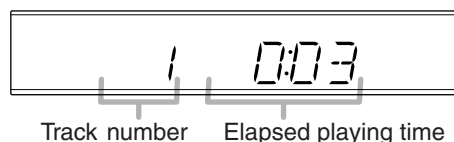
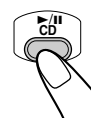

- The CD automatically stops when the last track of the CD has finished playing.

To stop playing, press .

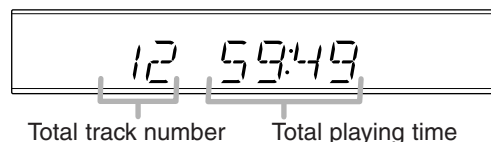

To remove the disc, press  CD on the remote control (or  on the unit).



- **If the CD cannot be read correctly (because it is scratched, for example) or an unreadable CD-R or CD-RW is inserted**
Playback will not start.
- **If no CD is inserted**
"NO DISC" appears on the display.
- **If the loaded CD has more than 21 tracks and you select 21st track or above**
"--:--" appears on the display instead of the playing time.



DO NOT try to open or close the CD tray by hand as it will be damaged.

Basic CD Operations

While playing a CD, you can do the following operations.

To stop playing for a moment

Press CD .

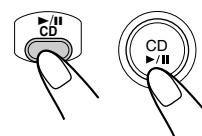

While pausing, the elapsed playing time flashes on the display.



To resume playing, press CD  again.

To go to another track

Press  or  repeatedly.

- :
Skips to the beginning of the next or succeeding tracks.
- :
Goes back to the beginning of the current or previous tracks.

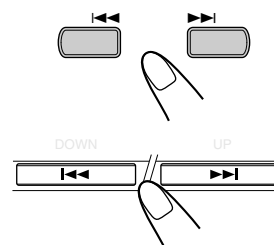

To go to another track directly using the number buttons



On the remote control ONLY:

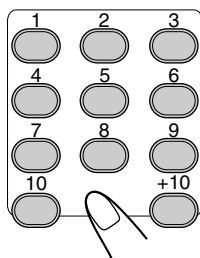

Pressing the number button(s) allows you to start playing the track number you want.

- Ex.:
- For track number 5, press 5.
 - For track number 15, press +10, then 5.
 - For track number 20, press +10, then 10.
 - For track number 32, press +10, +10, +10, then 2.



To locate a particular point in a track

During play, press and hold  or .

- : Fast-forwards the tracks.
- : Fast-reverses the tracks.

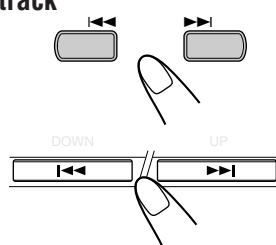



Programming the Playing Order of the Tracks —Program Play

You can arrange the order in which tracks play before you start playing. **You can program up to 20 tracks.**

On the remote control ONLY:

1 Load a CD.

- If the current playing source is not the CD player, press CD , then  before going to the next step.

2 Press PRGM (program).

The PRGM (program) indicator lights up on the display.



- If a program has been stored in memory, the program is called up.

3 Press UP or DOWN to select the track number, then press SET.

- You can select the track number directly using the number buttons. (See “To go to another track directly using the number buttons.”)

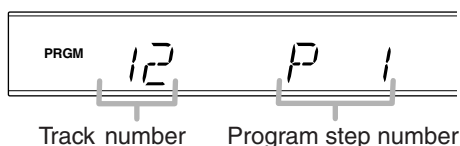

4 Repeat step 3 to program other tracks you want.

5 Press CD .

The tracks are played in the order you have programmed.

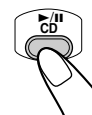

To stop playing, press .

To exit from Program Play mode, press PRGM before or after playing. The PRGM (program) indicator goes off.



To erase the program, press  twice.



- Disc ejection also erases the program.



If you try to program the 21st track “FULL” will appear on the display.

To check the program contents

You can check the program contents by pressing  or  before or after playback.

- : To check the contents in the programmed order.
- : To check the contents in the reverse order.

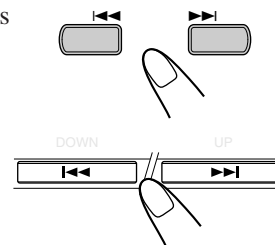

To modify the program

On the remote control ONLY:

Before or after playing, you can erase the last programmed track by pressing CANCEL.

- Each time you press the button, the last programmed track is erased from the program.



To add tracks in the program before playing, simply select the track numbers you want to add by following step 3 of the programming procedure.

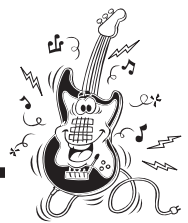

Playing at Random—Random Play

The tracks will play in no particular order when you use this mode.

On the remote control ONLY:

1 Load a CD.

- If the current playing source is not the CD player, press CD ►/II, then ■ before going to the next step.

2 Press RANDOM.

The RANDOM indicator lights up on the display and the tracks start playing at random.



3 Press CD ►/II.

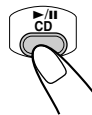
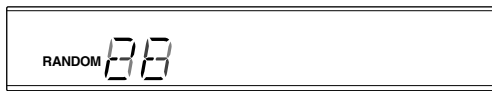

Random Play ends when all the tracks are played once.

To skip the current track, press ►►.

- You cannot go back to the previous track by pressing ◀◀.

To stop playing, press ■.

To exit from Random Play mode, press RANDOM again before or after playing. Random Play mode is canceled and Normal Play resumes.

- The RANDOM indicator goes off.

Repeating Tracks—Repeat Play

You can have all the tracks, the program or individual track currently playing to repeat as many times as you like.

On the remote control ONLY:

To repeat playing, press REPEAT before or during playing.



- Each time you press the button, Repeat Play mode changes as follows, and the following indicator lights up on the display:

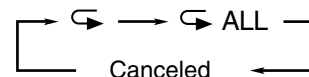

- ◀ : Repeats one track.
- ▶ ALL : In Normal Play mode, repeat all the tracks.
In Program Play mode, repeat all the tracks in the program.
In Random Play mode, repeats all the tracks in random order.

To stop playing, press ■.

To cancel Repeat Play mode, press REPEAT repeatedly until the repeat indicator goes off.

- Repeat Play mode remains in effect even when you change the play mode.
- In Random Play ▶ cannot be selected. If ▶ has been selected when you press RANDOM, it is canceled.

Prohibiting Disc Ejection—Tray Lock

You can lock the disc tray and prohibit to eject the CD.

- If the current playing source is not the CD player, press CD ►/II, then ■ before performing the procedure below.

On the unit ONLY:

To prohibit disc ejection, press STANDBY/ON ⏻/I while holding ■.

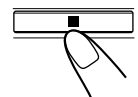

- If the disc tray is opened, close it first.

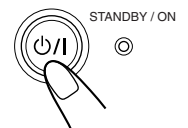

To cancel the prohibition and unlock the CD, press STANDBY/ON ⏻/I while holding ■.

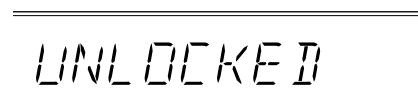

If you try to eject the CD while Tray Lock is in use “LOCKED” appears to inform you that the disc tray is locked.

Playing Back Tapes



You can play back type I, type II, and type IV tapes without changing any settings.

Playing Back a Tape

1 Press **▲ PUSH OPEN** on the unit.

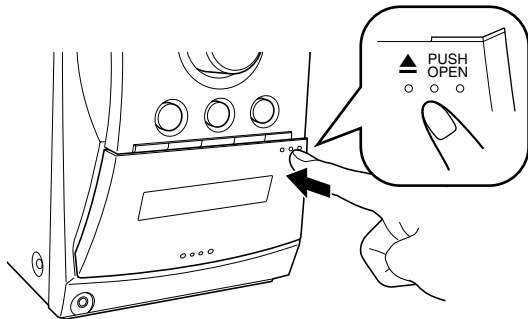

2 Put a cassette in with the exposed part of the tape down.

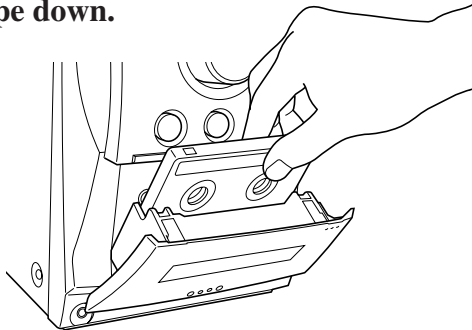

3 Press **▲ PUSH OPEN** again.

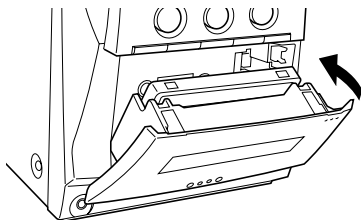



4 Press **TAPE ◀▶**.

The unit automatically turns on and the tape starts playing. The tape direction indicator (▶ or ◀) flashes slowly on the display.

• Each time you press the button, the tape direction changes.

- ▶ : plays the front side.
- ◀ : plays the reverse side.



When the tape plays to the end, the deck automatically stops if the reverse mode is set to  or . (See “To play both sides—Reverse Mode.”)

To stop playing, press **■**.

To fast-wind to the left or to the right, press **▶▶▶** or **◀◀◀** while the tape is not running.

The tape direction indicator (▶ or ◀) starts flashing quickly on the display.

To remove the cassette, press **▲ PUSH OPEN** on the unit.



To play both sides—Reverse Mode

You can set the deck to play just one side of a tape, both sides once, or both sides continuously.

Press **REV.MODE**.

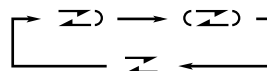
- Each time you press the button, reverse mode changes as follows:



-  : The deck automatically stops after playing both sides of the tape. Stops when playback in the ◀ direction is finished.
-  : The deck continues to play both sides of the tape until **■** is pressed.
-  : The deck automatically stops after playing one side of the tape.

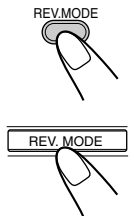

The use of the C-120 or thinner tape is not recommended, since characteristic deterioration may occur and this tape easily jams in the pinch-rollers and the capstans.



If no cassette is inserted

“NO TAPE” appears on the display.

Recording

IMPORTANT:

- It should be noted that it may be unlawful to re-record pre-recorded tapes, records, or discs without the consent of the owner of copyright in the sound or video recording, broadcast or cable programme and in any literary, dramatic, musical, or artistic embodied therein.
- The recording level is automatically set correctly, so it is not affected by the other sound settings. Thus, during recording you can adjust the sound you are actually listening to without affecting the recording level.
- If recordings you have made have excessive noise or static, the unit may be too close to a TV. Increase the distance between the TV and the unit.
- You can use type I tape for recording.

To protect your recording

Cassettes have two small tabs on the back to protect from unexpected erasure or re-recording.

To protect your recording, remove these tabs.

To re-record on a protected tape, cover the holes with adhesive tape.

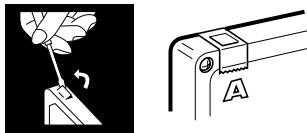

To keep the best recording and playback sound quality

If the heads, capstans, and pinch rollers of the cassette decks become dirty, the following will occur:

- Impaired sound quality
- Discontinuous sound
- Fading
- Incomplete erasure
- Difficulty in recording

To clean the heads, capstans, and pinch rollers

Use a cotton swab moistened with alcohol.

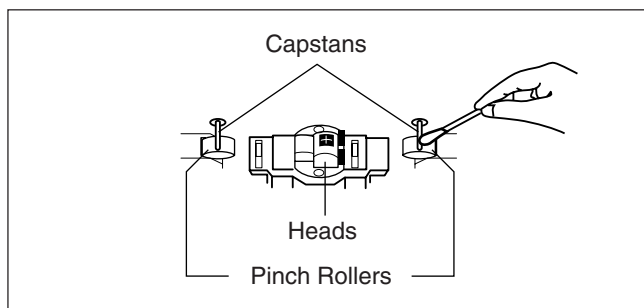

To demagnetize the heads

Turn off the unit, and use a head demagnetizer (available at electronics and audio shops).



At the start and end of cassette tapes

There is leader tape which cannot be recorded onto. Thus, when recording CDs or radio broadcasts, wind the leader tape first to ensure that the recording will be made without any music part lost.

Recording on a Tape

On the unit ONLY:

- 1 Put a recordable cassette in with the exposed part of the tape down.

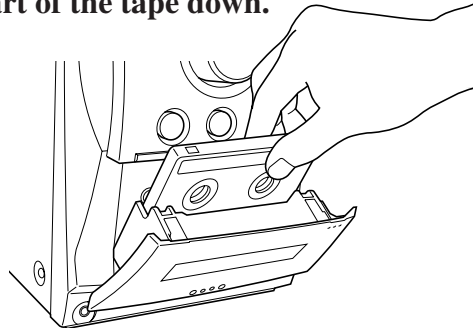

- 2 Close the cassette holder gently and check the recording direction for the tape.

- If the tape direction is not correct, press TAPE ◀▶ twice then ■ to change the tape direction.
- If you want to record on both sides of a tape, see “To record on both sides—Reverse Mode.”

- 3 Start playing the source—FM, AM or auxiliary equipment connected to AUX jacks.

- When the source is CD, see “CD Direct Recording” on page 18.

- 4 Press REC (recording).

The REC (recording) indicator lights up on the display and recording starts.

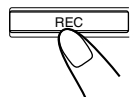

To stop recording, press ■.

The tape stops after 4 seconds.

To remove the cassette, press ▲ PUSH OPEN on the unit.

To record on both sides—Reverse Mode

Press REV.MODE (reverse mode) until the  indicator is lit.

- When using the Reverse Mode for recording, start recording in the forward (▶) direction first. Otherwise, recording will stop when recording is done only on one side (reverse) of the tape.

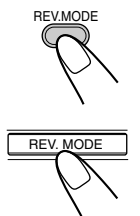



CD Direct Recording

Everything on the CD goes onto the tape in the order it is on the CD, or according to the order you have made for Program Play.

On the unit ONLY:

- 1 Put a recordable cassette in with the exposed part of the tape down.

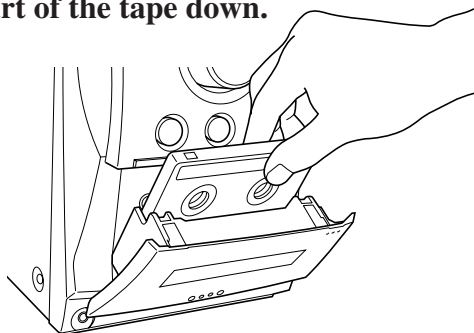

- 2 Load a CD.

- If the current playing source is not the CD player, press CD ►/||, then ■ before going to the next step.
 - If you do not want pauses of about 4 seconds recorded between selections, press CD ►/|| twice. Otherwise, non-recorded pause will be automatically recorded between selections.
- If you want to record on both sides of a tape, see “To record on both sides—Reverse Mode.”

- 3 Press REC (recording).

The REC (recording) indicator lights up on the display and recording starts. After recording, the CD player and cassette deck automatically stop.

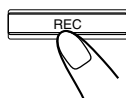

To stop while recording, press ■.

The tape stops after 4 seconds.

To remove the cassette, press ▲ PUSH OPEN on the unit.

To record on both sides—Reverse Mode

Press REV.MODE (reverse mode) until the  indicator is lit.

- When using the Reverse Mode for CD Direct Recording, start recording in the forward (►) direction first. When the tape reaches its end while recording a song in the forward direction (►), the last song will be re-recorded at the beginning of the reverse side (◄).

If you start recording on the reverse side (◄), recording will stop when recording is done only on one side (reverse) of the tape.

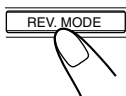
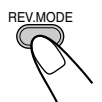

One Track Recording

This recording method is convenient when you record tracks while playing the CD. You can only record your favorite songs on the tape.

On the unit ONLY:

- 1 Put a recordable cassette in with the exposed part of the tape down.

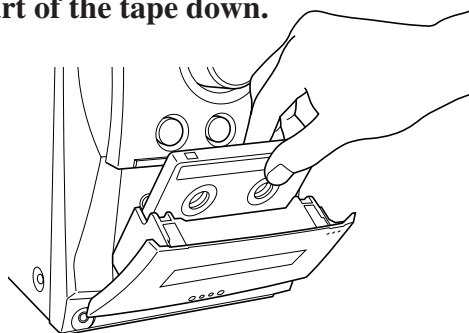

- 2 Play the track on the CD you wish to record.

- 3 Press REC (recording).

The CD player returns to the beginning of that track and the track is recorded on the tape.

After recording, the CD player and cassette deck automatically stop.

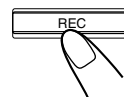

- 4 Repeat steps 2 and 3 to record other tracks you want.

To stop while recording, press ■.

The tape stops after 4 seconds.

To remove the cassette, press ▲ PUSH OPEN on the unit.



When making Sleep Timer settings while doing CD Direct recording

Set enough time to allow for the CD to finish playing; otherwise the power will go off before recording is completed.

Using the Timers

There are three timers available—Daily Timer, Recording Timer and Sleep Timer.

Before using the timers, you need to set the clock built in the unit (see page 9).

Using Daily Timer and Recording Timer

You can set the timer whether the unit is on or off.

When the on-time comes, the unit automatically turns on (⊕ (timer) indicator flashes just before the on-time, and continues flashing while the timer is operating). Then, when the off-time comes, the unit automatically turns off (on standby).

The timer setting remains in memory until you change it.

- When the DAILY indicator is lit on the display, the timer acts as the Daily Timer. Once the Daily Timer has been set, it will be activated at the same time everyday until the timer is turned off.
- When the REC indicator is lit on the display, the timer acts as the Recording Timer. After the Recording Timer has been performed, the details of the setting remain stored but the timer is turned off.

Before you start...

When using “TUNER” as the source to play, make sure to select the desired station before turning off the power.

- There is a time limit in doing the following steps. If the setting is canceled before you finish, start from step 1 again.

1 Press CLOCK/TIMER.

⊕ (timer) indicator lights up, and the timer mode indicator (DAILY or REC) and the current on-time flash on the display. The unit enters on-time setting mode.

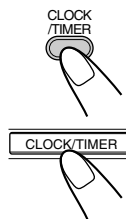

2 Set the on-time when you want the unit to turn on.

- 1) Press UP or DOWN to set the hour, then press CLOCK/TIMER.
- 2) Press UP or DOWN to set the minute, then press CLOCK/TIMER.

The unit enters off-time setting mode.

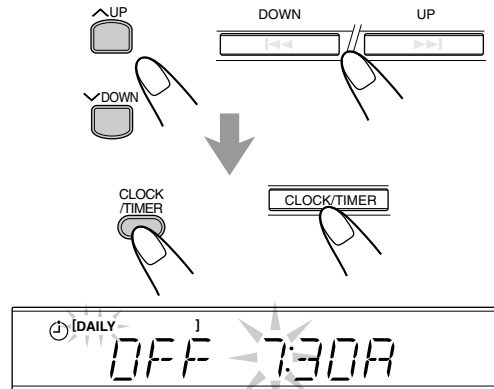

3 Set the off-time when you want the unit to turn off (on standby).

- 1) Press UP or DOWN to set the hour, then press CLOCK/TIMER.
- 2) Press UP or DOWN to set the minute, then press CLOCK/TIMER.

The unit enters source selecting mode.

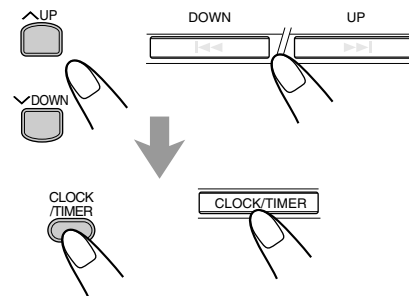

4 Press UP or DOWN to select the timer mode (Daily Timer or Recording Timer) and the source to play, then press CLOCK/TIMER.

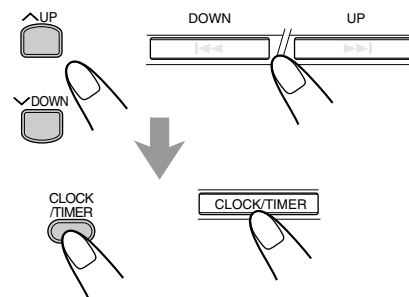



- Each time you press these buttons, the timer mode and the source change as follows:

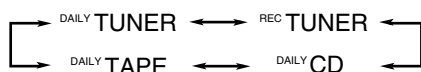

- DAILY TUNER : tunes in to the last station you were listening to. (Daily Timer)
- REC TUNER : records the last station you were listening to. (Recording Timer)
 - Put a recordable cassette into the deck.
- DAILY CD : plays a CD. (Daily Timer)
 - Load a CD.
- DAILY TAPE : plays a tape. (Daily Timer)
 - Make sure that the tape direction is correct.

5 Press UP or DOWN to set the volume level, then press CLOCK/TIMER.

- You can select the volume level (“VOLUME –” and “VOLUME 0” to “VOLUME 40”).
If you select “VOLUME –,” the volume is set to the last level when the unit has been turned off.
- **To turn off the volume while the Recording Timer (REC TUNER) is working,** set the volume level “VOLUME 0.”

The unit enters the clock setting mode.

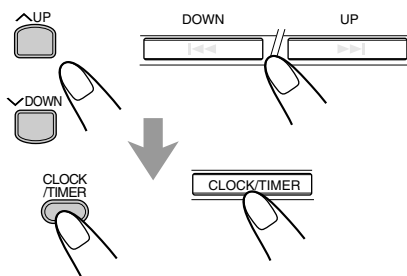

6 Adjust the clock.

- See “Setting the Clock” on page 9.

7 Press STANDBY/ON to turn off the unit (on standby) if you have set the timer with the unit turned on.

- When the timer turns on the unit, (timer) indicator and the selected timer mode indicator (DAILY or REC) start flashing.

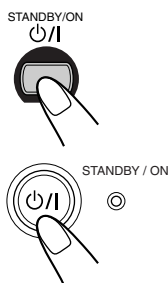

To cancel the setting, press and hold CLOCK/TIMER until (timer) indicator goes off from the display.



- **If the unit is turned on when the timer-on time comes**
Timer does not work.
- **When you unplug the AC power cord or if a power failure occurs**
The timer will be canceled. You need to set the clock first, then the timer again.

Using Sleep Timer

With Sleep Timer, you can fall asleep to music. You can set Sleep Timer when the unit is turned on.

How Sleep Timer actually works

The unit automatically turns off after the specified time length passes.

On the remote control ONLY:

1 Press SLEEP.

The time length until the shut-off time appears and the SLEEP indicator lights up on the display.



- Each time you press the button, the time length changes as follows:

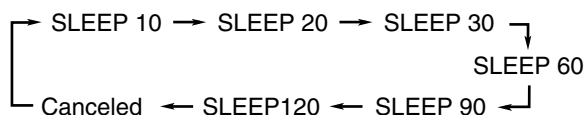

2 Wait for about 5 seconds after specifying the time length.

To check the remaining time until the shut-off time, press SLEEP once so that the remaining time until the shut-off time appears for about 5 seconds.

To change the shut-off time, press SLEEP repeatedly until the desired time length appears on the display.

To cancel the setting, press SLEEP repeatedly until the SLEEP indicator goes off.

- Sleep Timer is also canceled when you turn off the unit.



- **If you set the Sleep Timer after Daily Timer starts playing the selected source**
Daily Timer is canceled.
- **If you set the Sleep Timer after Recording Timer starts recording**
Recording Timer is canceled, but recording continues until Sleep Timer shuts off the power.

Maintenance



To get the best performance of the unit, keep your discs, tapes, and mechanism clean.

Handling discs



- Remove the disc from its case by holding it at the edge while pressing the center hole lightly.
- Do not touch the shiny surface of the disc, or bend the disc.
- Put the disc back in its case after use to prevent warping.

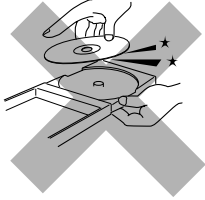

- Be careful not to scratch the surface of the disc when placing it back in its case.
- Avoid exposure to direct sunlight, temperature extremes, and moisture.



To clean the disc

Wipe the disc with a soft cloth in a straight line from center to edge.

DO NOT use any solvent—such as conventional record cleaner, spray, thinner, or benzine—to clean the disc.

Cleaning the unit

• Stains on the unit

Should be wiped off with a soft cloth. If the unit is heavily stained, wipe it with a cloth soaked in water-diluted neutral detergent and wrung well, then wipe clean with a dry cloth.

• Since the unit may deteriorate in quality, become damaged or get its paint peeled off, be careful about the followings.

- DO NOT wipe it with a hard cloth.
- DO NOT wipe it strong.
- DO NOT wipe it with thinner or benzine.
- DO NOT apply any volatile substance such as insecticides to it.
- DO NOT allow any rubber or plastic to remain in contact with it for a long time.

Handling cassette tapes

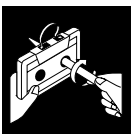

- If the tape is loose in its cassette, take up the slack by inserting a pencil in one of the reels and rotating.
- If the tape is loose, it may get stretched, cut, or caught in the cassette.

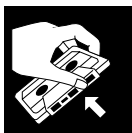

- Be careful not to touch the tape surface.



- Avoid the following places to store the tape:
 - In dusty places
 - In direct sunlight or heat
 - In moist areas
 - On a TV or speaker
 - Near a magnet

Troubleshooting



If you are having a problem with your unit, check this list for a possible solution before calling for service. If you cannot solve the problem from the hints given here, or the unit has been physically damaged, call a qualified person, such as your dealer, for service.

Symptom	Cause	Action
No sound is heard.	<ul style="list-style-type: none"> • Connections are incorrect or loose. • Headphones are connected. 	<ul style="list-style-type: none"> • Check all connections and make corrections. (See pages 6 to 8.) • Disconnect the headphones.
Hard to listen to broadcasts because of noise.	<ul style="list-style-type: none"> • Antennas are disconnected. • The AM loop antenna is too close to the unit. • The FM antenna is not properly extended and positioned. 	<ul style="list-style-type: none"> • Reconnect the antennas correctly and securely. • Change the position and direction of the AM loop antenna. • Extend the FM antenna at the best position.
The disc tray does not open or close.	The AC power cord is not plugged in.	Plug the AC power cord.
The disc does not play.	The disc is placed upside down.	Place the disc with the label side up.
The disc sound is discontinuous.	The disc is scratched or dirty.	Clean or replace the disc. (See page 23.)
The cassette holder cannot be opened.	Power supply from the AC power cord has been cut off while the tape was running.	Turn on the unit.
Impossible to record.	Small tabs on the back of the cassette are removed.	Cover the holes with adhesive tape.
Operations are disabled.	The built-in microprocessor may malfunction due to external electrical interference.	Unplug the AC power cord and then plug it back in.
Unable to operate the unit from the remote control.	<ul style="list-style-type: none"> • The path between the remote control and the remote sensor on the unit is blocked. • The batteries are exhausted. 	<ul style="list-style-type: none"> • Remove the obstruction. • Replace the batteries.

Specifications

Design and specifications are subject to change without notice.

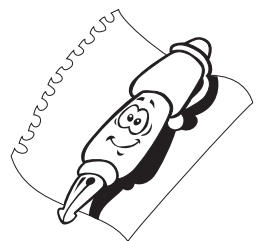

FS-L30 (CA-FSL30 and SP-UXL30)

Amplifier

Output Power:

**100 W (50 W + 50 W) at 6 Ω (10% THD)
60 W per channel, min. RMS, driven into 6 Ω at 1 kHz
with no more than 10% total harmonic distortion.**

Audio input sensitivity/Impedance (at 1 kHz)

AUX: 400 mV/48 kΩ

Digital output—OPTICAL DIGITAL OUT

Signal wave length: 660 nm

Output level: -21 dBm to -15 dBm

Speakers/Impedance: 6 Ω – 16 Ω

Tuner

FM tuning range: 87.5 MHz – 108.0 MHz

AM tuning range: 530 kHz – 1 710 kHz

CD player

Dynamic range: 85 dB

Signal-to-noise ratio: 90 dB

Wow and flutter: Immeasurable

Cassette deck

Frequency response:

Normal (type I): 60 Hz – 14 000 Hz

Wow and flutter: 0.15% (WRMS)

General

Power requirement: AC 120 V \sim , 60 Hz

Power consumption: 85 W (at operation)

5.8 W (on standby)

Dimensions (approx.):

170 mm x 286 mm x 319.5 mm (W/H/D)

(6 ³/₄ in. x 11 ⁵/₁₆ in. x 12 ⁵/₈ in.)

Mass (approx.): 12.7 kg (28.1 lbs)

Supplied Accessories

See page 6.

Speaker

Speaker units: Woofer: 12.0 cm (4 ³/₄ in.) cone x 1

Tweeter: 4.0 cm (1 ⁵/₈ in.) cone x 1

Impedance: Main speaker: 6 Ω

Dimensions (approx.):

160 mm x 285 mm x 186.5 mm (W/H/D)

(6 ⁵/₁₆ in. x 11 ¹/₄ in. x 7 ³/₈ in.)

Mass (approx.): 2.4 kg (5.3 lbs) each

Authorized Service Centers

QUALITY **JVC**[®] SERVICE

HOW TO LOCATE YOUR JVC SERVICE CENTER

TOLL FREE: 1 (800) 537-5722

<http://www.jvc.com>

Dear Customer,

In order to receive the most satisfaction from your purchase, please read the instruction booklet before operating the unit. In the event that repairs are necessary, please call 1 (800)537-5722 for your nearest authorized servicer or visit our website at **www.JVC.com**

Remember to retain your Bill of Sale for Warranty Service.

Do not service the television yourself

Caution

To prevent electrical shock, do not open the cabinet. There are no user serviceable parts inside. Please refer to qualified service personnel for repairs.

Accessories

To purchase accessories for your JVC product, please call toll free: 1 (800)882-2345 or on the web at **www.JVC.com**



LIMITED WARRANTY

AUDIO-1

JVC COMPANY OF AMERICA warrants this product and all parts thereof, except as set forth below ONLY TO THE ORIGINAL PURCHASER AT RETAIL to be FREE FROM DEFECTIVE MATERIALS AND WORKMANSHIP from the date of original retail purchase for the period as shown below. ("The Warranty Period")

PARTS	1 YR	LABOR	1 YR
-------	-------------	-------	-------------

THIS LIMITED WARRANTY IS VALID ONLY IN THE FIFTY (50) UNITED STATES, THE DISTRICT OF COLUMBIA AND IN COMMONWEALTH OF PUERTO RICO.

WHAT WE WILL DO:

If this product is found to be defective, JVC will repair or replace defective parts at no charge to the original owner. Such repair and replacement services shall be rendered by JVC during normal business hours at JVC authorized service centers. Parts used for replacement are warranted only for the remainder of the Warranty Period. All products and parts thereof may be brought to a JVC authorized service center on a carry-in basis except for Television sets having a screen size 25 inches and above which are covered on an in-home basis.

WHAT YOU MUST DO FOR WARRANTY SERVICE:

Return your product to a JVC authorized service center with a copy of your bill of sale. For your nearest JVC authorized service center, please call toll free: (800) 537-5722.

If service is not available locally, box the product carefully, preferably in the original carton, and ship, insured, with a copy of your bill of sale plus a letter of explanation of the problem to the nearest JVC Factory Service Center, the name and location of which will be given to you by the toll-free number.

If you have any questions concerning your JVC Product, please contact our Customer Relations Department.

WHAT IS NOT COVERED:

This limited warranty provided by JVC does not cover:

1. Products which have been subject to abuse, accident, alteration, modification, tampering, negligence, misuse, faulty installation, lack of reasonable care, or if repaired or serviced by anyone other than a service facility authorized by JVC to render such service, or if affixed to any attachment not provided with the products, or if the model number or serial number has been altered, tampered with, defaced or removed;
2. Initial installation and installation and removal for repair;
3. Operational adjustments covered in the Owner's Manual, normal maintenance, video and audio head cleaning;
4. Damage that occurs in shipment, due to act of God, and cosmetic damage;
5. Signal reception problems and failures due to line power surge;
6. Video Pick-up Tubes/CCD Image Sensor, Cartridge, Stylus (Needle) are covered for 90 days from the date of purchase;
7. Accessories
8. Batteries (except that Rechargeable Batteries are covered for 90 days from the date of purchase);

There are no express warranties except as listed above.

THE DURATION OF ANY IMPLIED WARRANTIES, INCLUDING THE IMPLIED WARRANTY OF MERCHANTABILITY, IS LIMITED TO THE DURATION OF THE EXPRESS WARRANTY HEREIN.

JVC SHALL NOT BE LIABLE FOR THE LOSS OF USE OF THE PRODUCT, INCONVENIENCE, LOSS OR ANY OTHER DAMAGES, WHETHER DIRECT, INCIDENTAL OR CONSEQUENTIAL (INCLUDING, WITHOUT LIMITATION, DAMAGE TO TAPES, RECORDS OR DISCS) RESULTING FROM THE USE OF THIS PRODUCT, OR ARISING OUT OF ANY BREACH OF THIS WARRANTY. ALL EXPRESS AND IMPLIED WARRANTIES, INCLUDING THE WARRANTIES OF MERCHANTABILITY AND FITNESS FOR PARTICULAR PURPOSE, ARE LIMITED TO THE WARRANTY PERIOD SET FORTH ABOVE.

Some states do not allow the exclusion of incidental or consequential damages or limitations on how long an implied warranty lasts, so these limitations or exclusions may not apply to you. This warranty gives you specific legal rights and you may also have other rights which vary from state to state.

JVC COMPANY OF AMERICA 1700 Valley Road
 DIVISION OF JVC AMERICAS CORP. Wayne, NJ 07470

REFURBISHED PRODUCTS CARRY A SEPARATE WARRANTY, THIS WARRANTY DOES NOT APPLY. FOR DETAILS OF REFURBISHED PRODUCT WARRANTY, PLEASE REFER TO THE REFURBISHED PRODUCT WARRANTY INFORMATION PACKAGED WITH EACH REFURBISHED PRODUCT.

For customer use:

Enter below the Model No. which is located either on the rear, bottom or side of the cabinet. Retain this information for future reference.

Model No. :	Serial No. :
Purchase data :	Name of dealer :



JVC
VICTOR COMPANY OF JAPAN, LIMITED